



**Guangzhou A&T Technologies Co.,Ltd.**

To find more fiber optic components best meeting your needs, contact us today or visit our website.

Address: 2F, No.4, West Nanwan Street, Huangpu District, Guangzhou, China

Postal Code: 510730

Phone: 86-20-82223917

Fax: 86-20-82223129

E-mail: 678@ant-optic.com

Skype: ant.amyhuang

Website: www.ant-optic.com



## FIBER OPTIC CATALOG

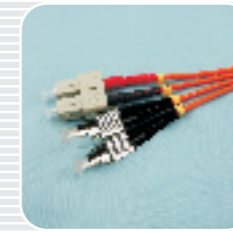

Local Sales Contact:

A & T Technologies (HK) Limited  
Rm2301 23/F., Futura Plaza  
111-113 How Ming Street, Kwun Tong, H.K.

Cardi Wong (Tel: 9178 8338 / 2342 5488)  
E-mail: sales@ antech-hk.com

**Guangzhou A&T Technologies Co.,Ltd.**

# About >>>>>> the Company

Guangzhou A&T Technologies Co., Ltd. is a leading supplier of fiber optic assemblies and components in mainland China.

Our large production plant is located in convenient Guangzhou. We boast a strong team of experienced technicians and production workers, and a monthly output of more than 10,000 optical couplers/splitters and 200,000pcs patch cords.

We have about 20 years of rich experience in fiber optic communication industry, and our expertise has allowed us to develop high performance components for a wide range of applications, including telecommunications, CATV, data-communications and multi-media industries.

Through co-operation with top optical communication research institutes in China, we continuously improve our manufacturing technologies, and develop new products, to be of better service to you.

Our customers include major domestic telecom service providers and equipment suppliers. We also export to Europe, Southeast Asia, Japan, Hong Kong and Taiwan.

We look forward to working with domestic and overseas telecom service providers, equipment manufacturers and system integrators. OEM orders are most welcome.

## Contact details

Address: 2F, No.4, West Nanwan Street, Huangpu District, Guangzhou, China

P.C: 510730

Phone: 86-20-82223917

Fax: 86-20-82223129

E-mail: 678@ant-optic.com

Skype: ant.amyhuang









## contents

- 01 Fiber optic couplers/splitters
- 02 Fiber optic patch cords, simplex
- 04 Fiber optic patch cords, duplex
- 07 Fiber optic armored patch cords, simplex
- 10 Fiber optic armored patch cords, duplex
- 13 12-fiber pigtails
- 13 Outdoor waterproof patch cords
- 13 Optical harnesses assemblies
- 14 Fiber optic cables, indoor
- 14 Fiber optic cables, armored
- 15 Fiber optic cables, outdoor
- 15 Fiber optic drop cables
- 16 Fiber optic adapters
- 17 Fiber optic attenuators
- 17 Fusion splicers
- 18 Optical taps
- 18 Handheld optical power meters
- 18 Handheld light sources
- 18 Splitter distribution boxes
- 18 Fiber cleavers
- 19 Visible fiber fault locators
- 19 Cleaning supplies

## Fiber optic couplers/splitters

	Product Code	Channel Quantity	Description	Notes
	16811101	2-way	FBT splitters, plastic housing, 1 metre pigtails with FC or SC connectors	Pigtail length and connector type can be customized
	16811102	3-way		
	16811103	4-way		
	16811104	8-way		
	16811105	16-way		
	16811206	2-way	FBT splitters, metal housing, with FC or SC connectors and adapters	
	16811207	3-way		
	16811208	4-way		
	16811209	8-way		
	16811310	2-way	FBT splitters, SS tube, 1 metre pigtails with FC or SC connectors	Pigtail length and connector type can be customized
	16811311	3-way		
	16811312	4-way		
	16811414	2-way	FBT splitters, plastic/metal slot box, with FC or SC connectors and adapters	
	16811415	4-way		
	16811416	8-way		
	16811417	16-way		
	16812118	2-way	PLC splitters, plastic housing, 1 metre pigtails with FC or SC connectors	Pigtail length and connector type can be customized
	16812119	4-way		
	16812120	8-way		
	16812121	16-way		
	16812122	32-way		
	16812223	2-way	PLC splitters, metal housing, with FC or SC connectors and adapters	
	16812224	4-way		
	16812225	8-way		
	16812326	2-way	PLC splitters, blockless, 1 metre pigtails with FC or SC connectors	Pigtail length and connector type can be customized
	16812327	4-way		
	16812328	8-way		
	16812329	16-way		
	16812330	32-way		
	16812431	2-way	PLC splitters, plastic/metal slot box, with FC or SC connectors and adapters	
	16812432	4-way		
	16812433	8-way		
	16812434	16-way		

## Fiber optic patch cords, simplex

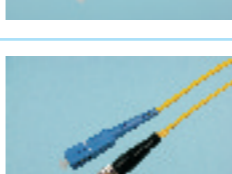
	Product Code	Cable Length	Description	Notes
	16821101	1 metre	LC/LC, simplex, singlemode 9/125um, 0.9/2.0/3.0, LSZH	<ul style="list-style-type: none"> <li>• Customized length available</li> <li>• Indoor and armored cable available</li> </ul>
	16821102	3 metre		
	16821103	5 metre		
	16821104	10 metre		
	16821105	20 metre		
	16821107	1 metre	LC/SC, simplex, singlemode 9/125um, 0.9/2.0/3.0, LSZH	<ul style="list-style-type: none"> <li>• Customized length available</li> <li>• Indoor and armored cable available</li> </ul>
	16821108	3 metre		
	16821109	5 metre		
	16821110	10 metre		
	16821111	20 metre		
	16821113	1 metre	LC/ST, simplex, singlemode 9/125um, 0.9/2.0/3.0, LSZH	<ul style="list-style-type: none"> <li>• Customized length available</li> <li>• Indoor and armored cable available</li> </ul>
	16821114	3 metre		
	16821115	5 metre		
	16821116	10 metre		
	16821117	20 metre		
	16821119	1 metre	LC/FC, simplex, singlemode 9/125um, 0.9/2.0/3.0, LSZH	<ul style="list-style-type: none"> <li>• Customized length available</li> <li>• Indoor and armored cable available</li> </ul>
	16821120	3 metre		
	16821121	5 metre		
	16821122	10 metre		
	16821123	20 metre		
	16821125	1 metre	SC/SC, simplex, singlemode 9/125um, 0.9/2.0/3.0, LSZH	<ul style="list-style-type: none"> <li>• Customized length available</li> <li>• Indoor and armored cable available</li> </ul>
	16821126	3 metre		
	16821127	5 metre		
	16821128	10 metre		
	16821129	20 metre		
	16821131	1 metre	SC/ST, simplex, singlemode 9/125um, 0.9/2.0/3.0, LSZH	<ul style="list-style-type: none"> <li>• Customized length available</li> <li>• Indoor and armored cable available</li> </ul>
	16821132	3 metre		
	16821133	5 metre		
	16821134	10 metre		
	16821135	20 metre		
	16821137	1 metre	SC/FC, simplex, singlemode 9/125um, 0.9/2.0/3.0, LSZH	<ul style="list-style-type: none"> <li>• Customized length available</li> <li>• Indoor and armored cable available</li> </ul>
	16821138	3 metre		
	16821139	5 metre		
	16821140	10 metre		
	16821141	20 metre		

	Product Code	Cable Length	Description	Notes
	16821143	1 metre	ST/ST, simplex, singlemode 9/125um, 0.9/2.0/3.0, LSZH	<ul style="list-style-type: none"> <li>• Customized length available</li> <li>• Indoor and armored cable available</li> </ul>
	16821144	3 metre		
	16821145	5 metre		
	16821146	10 metre		
	16821147	20 metre		
	16821149	1 metre	ST/FC, simplex, singlemode 9/125um, 0.9/2.0/3.0, LSZH	<ul style="list-style-type: none"> <li>• Customized length available</li> <li>• Indoor and armored cable available</li> </ul>
	16821150	3 metre		
	16821151	5 metre		
	16821152	10 metre		
	16821153	20 metre		
	16821155	1 metre	FC/FC, simplex, singlemode 9/125um, 0.9/2.0/3.0, LSZH	<ul style="list-style-type: none"> <li>• Customized length available</li> <li>• Indoor and armored cable available</li> </ul>
	16821156	3 metre		
	16821157	5 metre		
	16821158	10 metre		
	16821159	20 metre		
	16822101	1 metre	LC/LC, simplex, multimode 50/125um or 62.5/125um, 0.9/2.0/3.0, LSZH	<ul style="list-style-type: none"> <li>• Customized length available</li> <li>• Indoor and armored cable available</li> </ul>
	16822102	3 metre		
	16822103	5 metre		
	16822104	10 metre		
	16822105	20 metre		
	16822107	1 metre	LC/SC, simplex, multimode 50/125um or 62.5/125um, 0.9/2.0/3.0, LSZH	<ul style="list-style-type: none"> <li>• Customized length available</li> <li>• Indoor and armored cable available</li> </ul>
	16822108	3 metre		
	16822109	5 metre		
	16822110	10 metre		
	16822111	20 metre		
	16822113	1 metre	LC/ST, simplex, multimode 50/125um or 62.5/125um, 0.9/2.0/3.0, LSZH	<ul style="list-style-type: none"> <li>• Customized length available</li> <li>• Indoor and armored cable available</li> </ul>
	16822114	3 metre		
	16822115	5 metre		
	16822116	10 metre		
	16822117	20 metre		
	16822119	1 metre	LC/FC, simplex, multimode 50/125um or 62.5/125um, 0.9/2.0/3.0, LSZH	<ul style="list-style-type: none"> <li>• Customized length available</li> <li>• Indoor and armored cable available</li> </ul>
	16822120	3 metre		
	16822121	5 metre		
	16822122	10 metre		
	16822123	20 metre		
	16822125	1 metre	SC/SC, simplex, multimode 50/125um or 62.5/125um, 0.9/2.0/3.0, LSZH	<ul style="list-style-type: none"> <li>• Customized length available</li> <li>• Indoor and armored cable available</li> </ul>
	16822126	3 metre		
	16822127	5 metre		
	16822128	10 metre		
	16822129	20 metre		

	Product Code	Cable Length	Description	Notes
	16822131	1 metre	SC/ST, simplex, multimode 50/125um or 62.5/125um, 0.9/2.0/3.0, LSZH	<ul style="list-style-type: none"> <li>• Customized length available</li> <li>• Indoor and armored cable available</li> </ul>
	16822132	3 metre		
	16822133	5 metre		
	16822134	10 metre		
	16822135	20 metre		
	16822137	1 metre	SC/FC, simplex, multimode 50/125um or 62.5/125um, 0.9/2.0/3.0, LSZH	<ul style="list-style-type: none"> <li>• Customized length available</li> <li>• Indoor and armored cable available</li> </ul>
	16822138	3 metre		
	16822139	5 metre		
	16822140	10 metre		
	16822141	20 metre		
	16822143	1 metre	ST/ST, simplex, multimode 50/125um or 62.5/125um, 0.9/2.0/3.0, LSZH	<ul style="list-style-type: none"> <li>• Customized length available</li> <li>• Indoor and armored cable available</li> </ul>
	16822144	3 metre		
	16822145	5 metre		
	16822146	10 metre		
	16822147	20 metre		
	16822149	1 metre	ST/FC, simplex, multimode 50/125um or 62.5/125um, 0.9/2.0/3.0, LSZH	<ul style="list-style-type: none"> <li>• Customized length available</li> <li>• Indoor and armored cable available</li> </ul>
	16822150	3 metre		
	16822151	5 metre		
	16822152	10 metre		
	16822153	20 metre		
	16822155	1 metre	FC/FC, simplex, multimode 50/125um or 62.5/125um, 0.9/2.0/3.0, LSZH	<ul style="list-style-type: none"> <li>• Customized length available</li> <li>• Indoor and armored cable available</li> </ul>
	16822156	3 metre		
	16822157	5 metre		
	16822158	10 metre		
	16822159	20 metre		

### Fiber optic patch cords, duplex

	Product Code	Cable Length	Description	Notes
	16821201	1 metre	LC/LC, duplex, singlemode 9/125um, 2.0/3.0,LSZH	Customized length available
	16821202	3 metre		
	16821203	5 metre		
	16821204	10 metre		
	16821205	20 metre		
	16821207	1 metre	LC/SC, duplex, singlemode 9/125um, 2.0/3.0, LSZH	Customized length available
	16821208	3 metre		
	16821209	5 metre		
	16821210	10 metre		
	16821211	20 metre		

	Product Code	Cable Length	Description	Notes
	16821213	1 metre	LC/ST, duplex, singlemode 9/125um, 2.0/3.0, LSZH	Customized length available
	16821214	3 metre		
	16821215	5 metre		
	16821216	10 metre		
	16821217	20 metre		
	16821219	1 metre	LC/FC, duplex, singlemode 9/125um, 2.0/3.0, LSZH	Customized length available
	16821220	3 metre		
	16821221	5 metre		
	16821222	10 metre		
	16821223	20 metre		
	16821225	1 metre	SC/SC, duplex, singlemode 9/125um, 2.0/3.0, LSZH	Customized length available
	16821226	3 metre		
	16821227	5 metre		
	16821228	10 metre		
	16821229	20 metre		
	16821231	1 metre	SC/ST, duplex, singlemode 9/125um, 2.0/3.0, LSZH	Customized length available
	16821232	3 metre		
	16821233	5 metre		
	16821234	10 metre		
	16821235	20 metre		
	16821237	1 metre	SC/FC, duplex, singlemode 9/125um, 2.0/3.0, LSZH	Customized length available
	16821238	3 metre		
	16821239	5 metre		
	16821240	10 metre		
	16821241	20 metre		
	16821243	1 metre	ST/ST, duplex, singlemode 9/125um, 2.0/3.0, LSZH	Customized length available
	16821244	3 metre		
	16821245	5 metre		
	16821246	10 metre		
	16821247	20 metre		
	16821249	1 metre	ST/FC, duplex, singlemode 9/125um, 2.0/3.0, LSZH	Customized length available
	16821250	3 metre		
	16821251	5 metre		
	16821252	10 metre		
	16821253	20 metre		
	16821255	1 metre	FC/FC, duplex, singlemode 9/125um, 2.0/3.0, LSZH	Customized length available
	16821256	3 metre		
	16821257	5 metre		
	16821258	10 metre		
	16821259	20 metre		

	Product Code	Cable Length	Description	Notes
	16822201	1 metre	LC/LC, duplex, multimode (OM1,OM2,OM3,OM4) 50/125um or 62.5/125um, 2.0/3.0, LSZH	Customized length available
	16822202	3 metre		
	16822203	5 metre		
	16822204	10 metre		
	16822205	20 metre		
	16822207	1 metre	LC/SC, duplex, multimode (OM1,OM2,OM3,OM4) 50/125um or 62.5/125um, 2.0/3.0, LSZH	Customized length available
	16822208	3 metre		
	16822209	5 metre		
	16822210	10 metre		
	16822211	20 metre		
	16822213	1 metre	LC/ST, duplex, multimode (OM1,OM2,OM3,OM4) 50/125um or 62.5/125um, 2.0/3.0, LSZH	Customized length available
	16822214	3 metre		
	16822215	5 metre		
	16822216	10 metre		
	16822217	20 metre		
	16822219	1 metre	LC/FC, duplex, multimode (OM1,OM2,OM3,OM4) 50/125um or 62.5/125um, 2.0/3.0, LSZH	Customized length available
	16822220	3 metre		
	16822221	5 metre		
	16822222	10 metre		
	16822223	20 metre		
	16822225	1 metre	SC/SC, duplex, multimode (OM1,OM2,OM3,OM4) 50/125um or 62.5/125um, 2.0/3.0, LSZH	Customized length available
	16822226	3 metre		
	16822227	5 metre		
	16822228	10 metre		
	16822229	20 metre		
	16822231	1 metre	SC/ST, duplex, multimode (OM1,OM2,OM3,OM4) 50/125um or 62.5/125um, 2.0/3.0, LSZH	Customized length available
	16822232	3 metre		
	16822233	5 metre		
	16822234	10 metre		
	16822235	20 metre		
	16822237	1 metre	SC/FC, duplex, multimode (OM1,OM2,OM3,OM4) 50/125um or 62.5/125um, 2.0/3.0, LSZH	Customized length available
	16822238	3 metre		
	16822239	5 metre		
	16822240	10 metre		
	16822241	20 metre		
	16822243	1 metre	ST/ST, duplex, multimode (OM1,OM2,OM3,OM4) 50/125um or 62.5/125um, 2.0/3.0, LSZH	Customized length available
	16822244	3 metre		
	16822245	5 metre		
	16822246	10 metre		
	16822247	20 metre		

	Product Code	Cable Length	Description	Notes
	16822249	1 metre	ST/FC, duplex, multimode (OM1,OM2,OM3,OM4) 50/125um or 62.5/125um, 2.0/3.0, LSZH	Customized length available
	16822250	3 metre		
	16822251	5 metre		
	16822252	10 metre		
	16822253	20 metre		
	16822255	1 metre	FC/FC, duplex, multimode (OM1,OM2,OM3,OM4) 50/125um or 62.5/125um, 2.0/3.0, LSZH	Customized length available
	16822256	3 metre		
	16822257	5 metre		
	16822258	10 metre		
	16822259	20 metre		

### Fiber optic armored patch cords, simplex

	Product Code	Cable Length	Description	Notes
	16821101/ad	1 metre	LC/LC, simplex, singlemode 9/125um, 2.0/3.0, with stainless steel tube inside to provide extra crush resistance and avoid damage by rodents bite	Customized length available
	16821102/ad	3 metre		
	16821103/ad	5 metre		
	16821104/ad	10 metre		
	16821105/ad	20 metre		
	16821107/ad	1 metre	LC/SC, simplex, singlemode 9/125um, 2.0/3.0, with stainless steel tube inside to provide extra crush resistance and avoid damage by rodents bite	Customized length available
	16821108/ad	3 metre		
	16821109/ad	5 metre		
	16821110/ad	10 metre		
	16821111/ad	20 metre		
	16821113/ad	1 metre	LC/ST, simplex, singlemode 9/125um, 2.0/3.0, with stainless steel tube inside to provide extra crush resistance and avoid damage by rodents bite	Customized length available
	16821114/ad	3 metre		
	16821115/ad	5 metre		
	16821116/ad	10 metre		
	16821117/ad	20 metre		
	16821119/ad	1 metre	LC/FC, simplex, singlemode 9/125um, 2.0/3.0, with stainless steel tube inside to provide extra crush resistance and avoid damage by rodents bite	Customized length available
	16821120/ad	3 metre		
	16821121/ad	5 metre		
	16821122/ad	10 metre		
	16821123/ad	20 metre		
	16821125/ad	1 metre	SC/SC, simplex, singlemode 9/125um, 2.0/3.0, with stainless steel tube inside to provide extra crush resistance and avoid damage by rodents bite	Customized length available
	16821126/ad	3 metre		
	16821127/ad	5 metre		
	16821128/ad	10 metre		
	16821129/ad	20 metre		

	Product Code	Cable Length	Description	Notes
	16821131/ad	1 metre	SC/ST, simplex, singlemode 9/125um, 2.0/3.0, with stainless steel tube inside to provide extra crush resistance and avoid damage by rodents bite	Customized length available
	16821132/ad	3 metre		
	16821133/ad	5 metre		
	16821134/ad	10 metre		
	16821135/ad	20 metre		
	16821137/ad	1 metre	SC/FC, simplex, singlemode 9/125um, 2.0/3.0, with stainless steel tube inside to provide extra crush resistance and avoid damage by rodents bite	Customized length available
	16821138/ad	3 metre		
	16821139/ad	5 metre		
	16821140/ad	10 metre		
	16821141/ad	20 metre		
	16821143/ad	1 metre	ST/ST, simplex, singlemode 9/125um, 2.0/3.0, with stainless steel tube inside to provide extra crush resistance and avoid damage by rodents bite	Customized length available
	16821144/ad	3 metre		
	16821145/ad	5 metre		
	16821146/ad	10 metre		
	16821147/ad	20 metre		
	16821149/ad	1 metre	ST/FC, simplex, singlemode 9/125um, 2.0/3.0, with stainless steel tube inside to provide extra crush resistance and avoid damage by rodents bite	Customized length available
	16821150/ad	3 metre		
	16821151/ad	5 metre		
	16821152/ad	10 metre		
	16821153/ad	20 metre		
	16821155/ad	1 metre	FC/FC, simplex, singlemode 9/125um, 2.0/3.0, with stainless steel tube inside to provide extra crush resistance and avoid damage by rodents bite	Customized length available
	16821156/ad	3 metre		
	16821157/ad	5 metre		
	16821158/ad	10 metre		
	16821159/ad	20 metre		
	16822101/ad	1 metre	LC/LC, simplex, multimode 50/125um or 62.5/125um, 2.0/3.0, with stainless steel tube inside to provide extra crush resistance and avoid damage by rodents bite	Customized length available
	16822102/ad	3 metre		
	16822103/ad	5 metre		
	16822104/ad	10 metre		
	16822105/ad	20 metre		
	16822107/ad	1 metre	LC/SC, simplex, multimode 50/125um or 62.5/125um, 2.0/3.0, with stainless steel tube inside to provide extra crush resistance and avoid damage by rodents bite	Customized length available
	16822108/ad	3 metre		
	16822109/ad	5 metre		
	16822110/ad	10 metre		
	16822111/ad	20 metre		
	16822113/ad	1 metre	LC/ST, simplex, multimode 50/125um or 62.5/125um, 2.0/3.0, with stainless steel tube inside to provide extra crush resistance and avoid damage by rodents bite	Customized length available
	16822114/ad	3 metre		
	16822115/ad	5 metre		
	16822116/ad	10 metre		
	16822117/ad	20 metre		

	Product Code	Cable Length	Description	Notes
	16822119/ad	1 metre	LC/FC, simplex, multimode 50/125um or 62.5/125um, 2.0/3.0, with stainless steel tube inside to provide extra crush resistance and avoid damage by rodents bite	Customized length available
	16822120/ad	3 metre		
	16822121/ad	5 metre		
	16822122/ad	10 metre		
	16822123/ad	20 metre		
	16822125/ad	1 metre	SC/SC, simplex, multimode 50/125um or 62.5/125um, 2.0/3.0, with stainless steel tube inside to provide extra crush resistance and avoid damage by rodents bite	Customized length available
	16822126/ad	3 metre		
	16822127/ad	5 metre		
	16822128/ad	10 metre		
	16822129/ad	20 metre		
	16822131/ad	1 metre	SC/ST, simplex, multimode 50/125um or 62.5/125um, 2.0/3.0, with stainless steel tube inside to provide extra crush resistance and avoid damage by rodents bite	Customized length available
	16822132/ad	3 metre		
	16822133/ad	5 metre		
	16822134/ad	10 metre		
	16822135/ad	20 metre		
	16822137/ad	1 metre	SC/FC, simplex, multimode 50/125um or 62.5/125um, 2.0/3.0, with stainless steel tube inside to provide extra crush resistance and avoid damage by rodents bite	Customized length available
	16822138/ad	3 metre		
	16822139/ad	5 metre		
	16822140/ad	10 metre		
	16822141/ad	20 metre		
	16822143/ad	1 metre	ST/ST, simplex, multimode 50/125um or 62.5/125um, 2.0/3.0, with stainless steel tube inside to provide extra crush resistance and avoid damage by rodents bite	Customized length available
	16822144/ad	3 metre		
	16822145/ad	5 metre		
	16822146/ad	10 metre		
	16822147/ad	20 metre		
	16822149/ad	1 metre	ST/FC, simplex, multimode 50/125um or 62.5/125um, 2.0/3.0, with stainless steel tube inside to provide extra crush resistance and avoid damage by rodents bite	Customized length available
	16822150/ad	3 metre		
	16822151/ad	5 metre		
	16822152/ad	10 metre		
	16822153/ad	20 metre		
	16822155/ad	1 metre	FC/FC, simplex, multimode 50/125um or 62.5/125um, 2.0/3.0, with stainless steel tube inside to provide extra crush resistance and avoid damage by rodents bite	Customized length available
	16822156/ad	3 metre		
	16822157/ad	5 metre		
	16822158/ad	10 metre		
	16822159/ad	20 metre		

## Fiber optic armored patch cords, duplex

	Product Code	Cable Length	Description	Notes
	16821201/ad	1 metre	LC/LC, duplex, singlemode 9/125um, 2.0/3.0, with stainless steel tube inside to provide extra crush resistance and avoid damage by rodents bite	Customized length available
	16821202/ad	3 metre		
	16821203/ad	5 metre		
	16821204/ad	10 metre		
	16821205/ad	20 metre		
	16821207/ad	1 metre	LC/SC, duplex, singlemode 9/125um, 2.0/3.0, with stainless steel tube inside to provide extra crush resistance and avoid damage by rodents bite	Customized length available
	16821208/ad	3 metre		
	16821209/ad	5 metre		
	16821210/ad	10 metre		
	16821211/ad	20 metre		
	16821213/ad	1 metre	LC/ST, duplex, singlemode 9/125um, 2.0/3.0, with stainless steel tube inside to provide extra crush resistance and avoid damage by rodents bite	Customized length available
	16821214/ad	3 metre		
	16821215/ad	5 metre		
	16821216/ad	10 metre		
	16821217/ad	20 metre		
	16821219/ad	1 metre	LC/FC, duplex, singlemode 9/125um, 2.0/3.0, with stainless steel tube inside to provide extra crush resistance and avoid damage by rodents bite	Customized length available
	16821220/ad	3 metre		
	16821221/ad	5 metre		
	16821222/ad	10 metre		
	16821223/ad	20 metre		
	16821225/ad	1 metre	SC/SC, duplex, singlemode 9/125um, 2.0/3.0, with stainless steel tube inside to provide extra crush resistance and avoid damage by rodents bite	Customized length available
	16821226/ad	3 metre		
	16821227/ad	5 metre		
	16821228/ad	10 metre		
	16821229/ad	20 metre		
	16821231/ad	1 metre	SC/ST, duplex, singlemode 9/125um, 2.0/3.0, with stainless steel tube inside to provide extra crush resistance and avoid damage by rodents bite	Customized length available
	16821232/ad	3 metre		
	16821233/ad	5 metre		
	16821234/ad	10 metre		
	16821235/ad	20 metre		



	Product Code	Cable Length	Description	Notes
	16821237/ad	1 metre	SC/FC, duplex, singlemode 9/125um, 2.0/3.0, with stainless steel tube inside to provide extra crush resistance and avoid damage by rodents bite	Customized length available
	16821238/ad	3 metre		
	16821239/ad	5 metre		
	16821240/ad	10 metre		
	16821241/ad	20 metre		
	16821243/ad	1 metre	ST/ST, duplex, singlemode 9/125um, 2.0/3.0, with stainless steel tube inside to provide extra crush resistance and avoid damage by rodents bite	Customized length available
	16821244/ad	3 metre		
	16821245/ad	5 metre		
	16821246/ad	10 metre		
	16821247/ad	20 metre		
	16821249/ad	1 metre	ST/FC, duplex, singlemode 9/125um, 2.0/3.0, with stainless steel tube inside to provide extra crush resistance and avoid damage by rodents bite	Customized length available
	16821250/ad	3 metre		
	16821251/ad	5 metre		
	16821252/ad	10 metre		
	16821253/ad	20 metre		
	16821255/ad	1 metre	FC/FC, duplex, singlemode 9/125um, 2.0/3.0, with stainless steel tube inside to provide extra crush resistance and avoid damage by rodents bite	Customized length available
	16821256/ad	3 metre		
	16821257/ad	5 metre		
	16821258/ad	10 metre		
	16821259/ad	20 metre		
	16822201/ad	1 metre	LC/LC, duplex, multimode 50/125um or 62.5/125um, 2.0/3.0, with stainless steel tube inside to provide extra crush resistance and avoid damage by rodents bite	Customized length available
	16822202/ad	3 metre		
	16822203/ad	5 metre		
	16822204/ad	10 metre		
	16822205/ad	20 metre		
	16822207/ad	1 metre	LC/SC, duplex, multimode 50/125um or 62.5/125um, 2.0/3.0, with stainless steel tube inside to provide extra crush resistance and avoid damage by rodents bite	Customized length available
	16822208/ad	3 metre		
	16822209/ad	5 metre		
	16822210/ad	10 metre		
	16822211/ad	20 metre		
	16822213/ad	1 metre	LC/ST, duplex, multimode 50/125um or 62.5/125um, 2.0/3.0, with stainless steel tube inside to provide extra crush resistance and avoid damage by rodents bite	Customized length available
	16822214/ad	3 metre		
	16822215/ad	5 metre		
	16822216/ad	10 metre		
	16822217/ad	20 metre		

	Product Code	Cable Length	Description	Notes
	16822219/ad	1 metre	LC/FC, duplex, multimode 50/125um or 62.5/125um, 2.0/3.0, with stainless steel tube inside to provide extra crush resistance and avoid damage by rodents bite	Customized length available
	16822220/ad	3 metre		
	16822221/ad	5 metre		
	16822222/ad	10 metre		
	16822223/ad	20 metre		
	16822225/ad	1 metre	SC/SC, duplex, multimode 50/125um or 62.5/125um, 2.0/3.0, with stainless steel tube inside to provide extra crush resistance and avoid damage by rodents bite	Customized length available
	16822226/ad	3 metre		
	16822227/ad	5 metre		
	16822228/ad	10 metre		
	16822229/ad	20 metre		
	16822231/ad	1 metre	SC/ST, duplex, multimode 50/125um or 62.5/125um, 2.0/3.0, with stainless steel tube inside to provide extra crush resistance and avoid damage by rodents bite	Customized length available
	16822232/ad	3 metre		
	16822233/ad	5 metre		
	16822234/ad	10 metre		
	16822235/ad	20 metre		
	16822237/ad	1 metre	SC/FC, duplex, multimode 50/125um or 62.5/125um, 2.0/3.0, with stainless steel tube inside to provide extra crush resistance and avoid damage by rodents bite	Customized length available
	16822238/ad	3 metre		
	16822239/ad	5 metre		
	16822240/ad	10 metre		
	16822241/ad	20 metre		
	16822243/ad	1 metre	ST/ST, duplex, multimode 50/125um or 62.5/125um, 2.0/3.0, with stainless steel tube inside to provide extra crush resistance and avoid damage by rodents bite	Customized length available
	16822244/ad	3 metre		
	16822245/ad	5 metre		
	16822246/ad	10 metre		
	16822247/ad	20 metre		
	16822249/ad	1 metre	ST/FC, duplex, multimode 50/125um or 62.5/125um, 2.0/3.0, with stainless steel tube inside to provide extra crush resistance and avoid damage by rodents bite	Customized length available
	16822250/ad	3 metre		
	16822251/ad	5 metre		
	16822252/ad	10 metre		
	16822253/ad	20 metre		
	16822255/ad	1 metre	FC/FC, duplex, multimode 50/125um or 62.5/125um, 2.0/3.0, with stainless steel tube inside to provide extra crush resistance and avoid damage by rodents bite	Customized length available
	16822256/ad	3 metre		
	16822257/ad	5 metre		
	16822258/ad	10 metre		
	16822259/ad	20 metre		

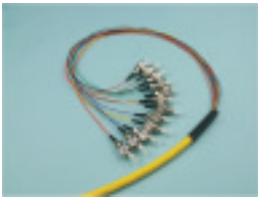
## 12-fiber pigtails

	Product Code	Cable Length	Description	Notes
	16831301	1 metre	With LC/SC/FC/ST connectors, 12-fiber, ribbon type, singlemode 9/125um, 0.9mm	Customized length available; 4, 6, 8 core available
	16831302	1 metre	With LC/SC/FC/ST connectors, 12-fiber, bundle type, singlemode 9/125um, 0.9mm	Customized length available; 4, 6, 8 core available



## Outdoor waterproof patch cords

	Product Code	Connector Type	Description	Notes
	16831303	ODC-2	Waterproof ODC connector and cable; the other end can be ODC or LC/SC/FC/ST connectors; can be 2 or 4 fibers	Customized length available
	16831304	ODC-4		
	16831305	PDLC	Duplex LC connectors protected by special designed kits; outdoor cable; the other end can be PDLC or SC/FC/ST connectors; can be 1 or 2 fibers	Customized length available



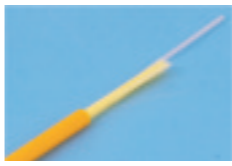
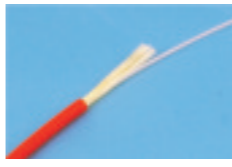

## Optical harnesses assemblies

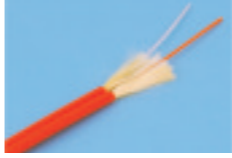
	Product Code	Cable Length	Description	Notes
	16831306	customized	Various optical cable harnesses based on customer drawings	Customized length available



## Fiber optic cables, indoor

	Product Code	OD	Description	Notes
	16841101	0.9mm	Singlemode 9/125um, simplex	
	16841102	2.0mm		
	16841103	3.0mm		
	16841201	0.9mm	Multimode 50/125 or 62.5/125um, simplex	
	16841202	2.0mm		
	16841203	3.0mm		
	16842101	2.0mm	Singlemode 9/125um, duplex	
	16842102	3.0mm		
	16842201	2.0mm	Multimode (OM1, OM2, OM3, OM4) 50/125 or 62.5/125um, duplex	
	16842202	3.0mm		

## Fiber optic cables, armored

	Product Code	OD	Description	Notes
	16841101/ad	2.0mm	Singlemode 9/125um, simplex, with stainless steel tube inside to provide extra crush resistance and avoid damage by rodents bite	
	16841102/ad	3.0mm		
	16841201/ad	2.0mm	Multimode 50/125 or 62.5/125um, simplex, with stainless steel tube inside to provide extra crush resistance and avoid damage by rodents bite	
	16841202/ad	3.0mm		
	16842101/ad	2.0mm	Singlemode 9/125um, duplex, with stainless steel tube inside to provide extra crush resistance and avoid damage by rodents bite	
	16842102/ad	3.0mm		
	16842201/ad	2.0mm	Multimode 50/125 or 62.5/125um, duplex, with stainless steel tube inside to provide extra crush resistance and avoid damage by rodents bite	
	16842202/ad	3.0mm		

## Fiber optic cables, outdoor

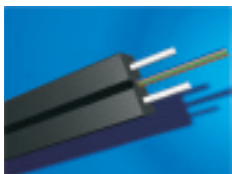
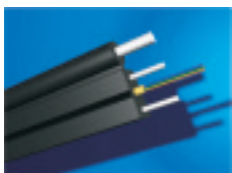

	Product Code	Fiber Count	Description	Notes
	16841101/od	2	Singlemode 9/125um, various structures available upon request	Customized fiber count available
	16841102/od	4		
	16841103/od	6		
	16841104/od	8		
	16841105/od	12		
	16841106/od	24		
	16841107/od	36		
	16841108/od	48		
	16841109/od	72		
	16841110/od	96		
	16841201/od	2	Multimode 50/125 or 62.5/125um, various structures available upon request	Customized fiber count available
	16841202/od	4		
	16841203/od	6		
	16841204/od	8		
	16841205/od	12		
	16841206/od	24		
	16841207/od	36		
	16841208/od	48		
	16841209/od	72		
	16841210/od	96		

## Fiber optic drop cables

	Product Code	Fiber Count	Description	Notes
	16841101/dp	1	Singlemode (G657A, G657A2), 9/125um, figure 8	Customized fiber count available
	16841102/dp	2		
	16841103/dp	4		
	16841104/dp	2	Singlemode (G657A, G657A2), 9/125um, self-support	Customized fiber count available
	16841105/dp	12		

## Fiber optic adapters

	Product Code	Mode	Description	Notes
	16851101	SM, MM	FC/FC, simplex	
	16851102	SM/APC		
	16851103	SM/UPC	SC/SC, simplex	
	16851104	SM/APC		
	16851105	MM/PC		
	16851106	SM/UPC	SC/SC, duplex	
	16851107	SM/APC		
	16851108	MM/PC		
	16851109	SM/UPC	LC/LC, simplex	
	16851110	SM/APC		
	16851111	MM/PC		
	16851112	SM/UPC	LC/LC, duplex	
	16851113	SM/APC		
	16851114	MM/PC		
	16851115	SM/UPC	LC/LC, quadplex	
	16851116	SM/APC		
	16851117	MM/PC		
	16851118	SM/UPC	ST/ST, simplex	
	16851119	SM/APC		
	16851120	MM/PC		
	16851121	SM/UPC	ST/ST, duplex	
	16851122	SM/APC		
	16851123	MM/PC		
	16851124	SM/UPC	SC-ST	
	16851125	SM/UPC	SC-FC	

	Product Code	Mode	Description	Notes
	16851126	SM/UPC	ST-FC	
	16851127	SM/UPC	LC-SC	

## Fiber optic attenuators

	Product Code	Polish Type	Description	Notes
	16861101	UPC	FC, adapter type/bulk-head	
	16861102	APC		
	16861103	UPC	FC, male-female/plug-in	
	16861104	APC		
	16861105	UPC	FC, attenuation value adjustable	
	16861106	UPC	SC, adapter type/bulk-head	
	16861107	APC		
	16861108	UPC	SC, male-female/plug-in	
	16861109	APC		
	16861110	UPC	LC, adapter type/bulk-head	
	16861111	APC		

## Fusion splicers

	Product Code	Description	Notes
	16871105	Single fiber cleaver, applicable to SM, MM, DS and NZDS fibers; 5.7" monitor; international version of menu	
	16871106	Single fiber cleaver, applicable to SM, MM, DS and NZDS fibers; 3.5" monitor; international version of menu	

## Optical taps

	Product Code	Port	Description	Notes
	16871101	A1X1	1 inline network port pair; 1 monitor output port pair	
	16871102	A2X2	2 inline network port pair; 2 monitor output port pair	
	16871103	A6X6	6 inline network port pair; 6 monitor output port pair	
	16871104	A12X12	12 inline network port pair; 12 monitor output port pair	

## Handheld optical power meters

	Product Code	Product Level	Description	Notes
	16871107	Basic	FP-LD laser; wavelength range 650~1700nm; output power -6~-7	
	16871108	Advance		

## Handheld light sources

	Product Code	Product Level	Description	Notes
	16871109	Basic	FP-LD laser; tone generation; adjustable output power	
	16871110	Advance		

## Splitter distribution boxes

	Product Code	Application	Description	Notes
	16871111	For blockless splitters	Can accommodate 8-way and 16-way optical splitters; can be mounted on pole, wall	
	16871112	For module type splitters		



## Fiber cleavers

	Product Code	Description	Notes
	16871111	Applicable to 250&900um fiber; up to 40,000 highly precise cuts; easy handling and no special skills needed	
	16871112	Spare blade for 16871111	

## Visible fiber fault locators

	Product Code	Laser Range	Description	Notes
	16871115	5KM	FP-LD emitter; applicable for locating fiber faults like crack, bending, etc; for fault checking in OTDR blind area; for end-to-end recognition; for optimizing mechanical splicing points	
	16871116	10KM		
	16871117	20KM		
	16871118	30KM		

## Cleaning supplies

	Product Code	Description	Notes
	16871119	Fiber cleaners/cleaning cassettes, applicable to SC, FC, MU, LC, ST, D4, DIN connectors	
	16871120	One-click cleaner, two types available, respectively applicable to SC/FC/ST and LC/MU connectors	
	16871121	Cleaning swabs, two types available, respectively applicable to SC/FC/ST and LC/MU connectors	
	16871122	Cleaning wipes, dry wipes and IPA wipes available	
	16871123	Clean air/compressed bottle air, 200ml, easy to clean all types of connectors, PCBs and etc.	
	16871124	Cleaning kits, including fiber cleaners, swabs, compressed bottle air, wipes, etc	
	16871125	Alcohol bottles, 120ml and 250ml available	
	16871126	Handheld fiber microscopes, 200X and 400X available	